



ALBUQUERQUE VAULT COMPANY

PRE-CAST
CONCRETE
PRODUCTS

300 Airport Dr., NW * Albuquerque, NM 87121 * Phone: 505-836-4404 / Fax: 505-836-5663

Detail # ST-1500-H20

Not To Scale

Dec., 2012

1,500 GALLON H-20 SEPTIC TANK

GENERAL NOTES:

- Design specifications conform to latest ASTM C1227 specifications for "Precast Concrete Water and Wastewater Structures."
- Concrete compressive strength 4,000 psi minimum.
- Steel reinforcing design to conform to the requirements of ASTM C890 specifications for "Structural Design Loading for Water and Wastewater Structures" and shall utilize grade 60 rebars conforming to the requirements of ASTM A615 or WWF conforming to the requirements of ASTM A185 or both.
- Additional reinforcing at all openings.
- Casting / Top provided and installed by contractor / customer per job requirements. 2", 3", 4" & 6" grade rings can be supplied by Albuquerque Vault Co. or field adjusted, using approved methods by contractor.
- Pipe penetration locations per job requirements. Pipe inlet and outlet locations to have cast-in-place boots. Pipe to be installed by contractor.
- Joints to be sealed with 1" diameter butyl rubber joint sealant conforming to the requirements of latest AASHTO specifications M-198 and meets federal specification SS-S-0021(210-A).
- Method of manufacture is wet cast.
- Sections are monolithic. Weights:
Top Section 5,740 ± lbs.
Riser Section 5,610 ± lbs.
Bottom Section 9,600 ± lbs.
- Inlet and outlet requirements such as tee's and/or effluent filter supplied and installed by contractor.
- Excavation hole bottom shall be 2' wider & 2' longer than total outside dimensions.
- Designed for H-20 loading.

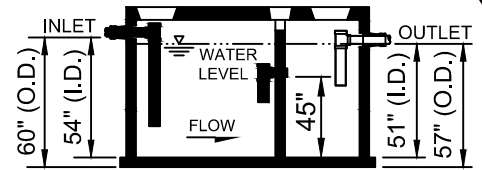

ELEVATION

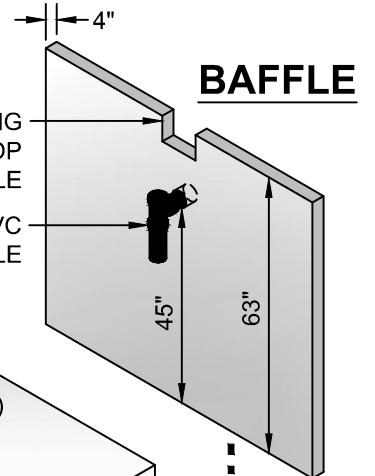

BAFFLE

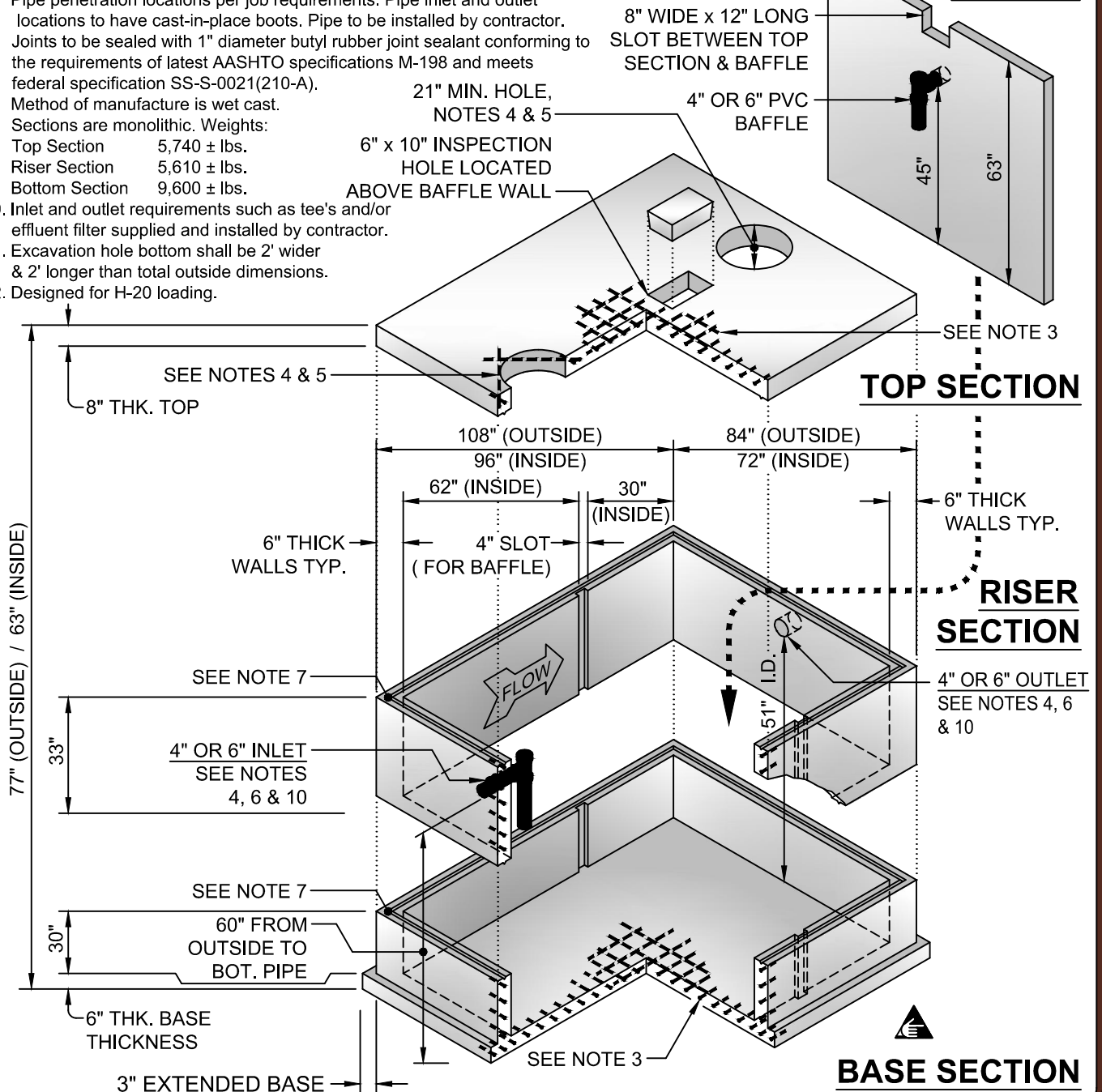

TOP SECTION

RISER SECTION

BASE SECTION